

uitwerkbijlage

Naam kandidaat _____ Kandidaatnummer _____

5

Reactieschema

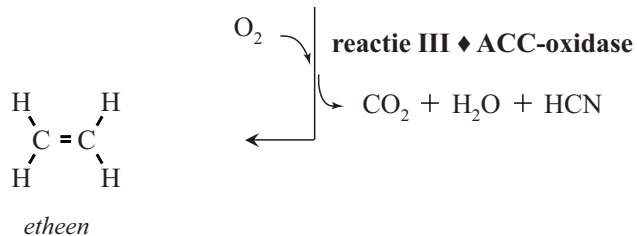
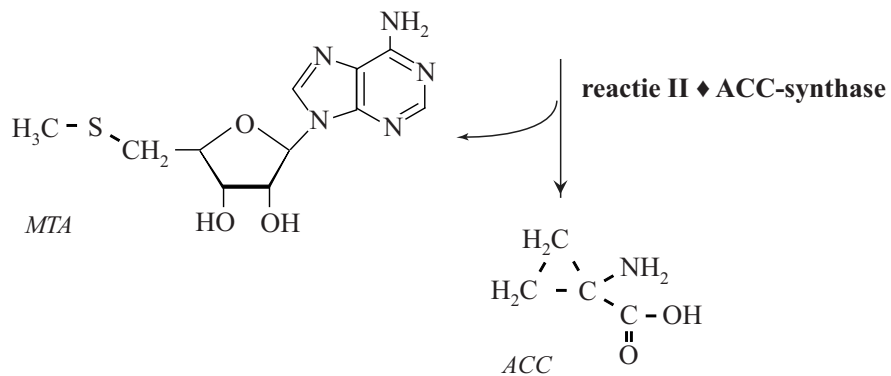
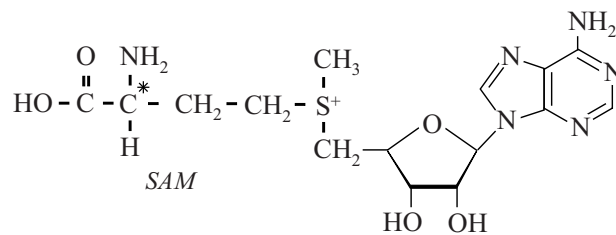
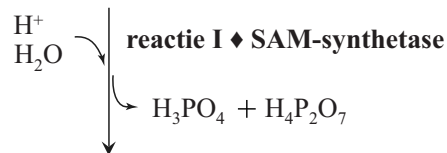
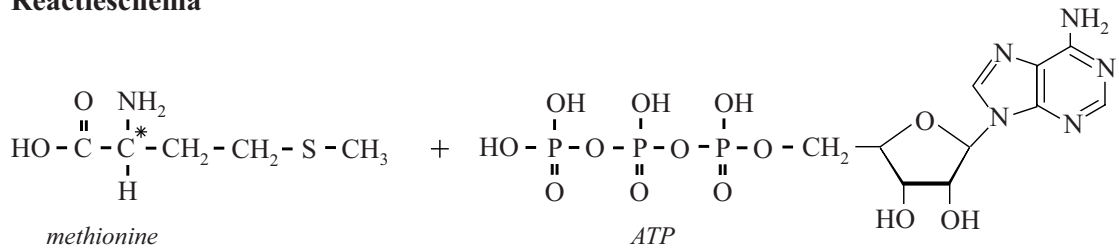

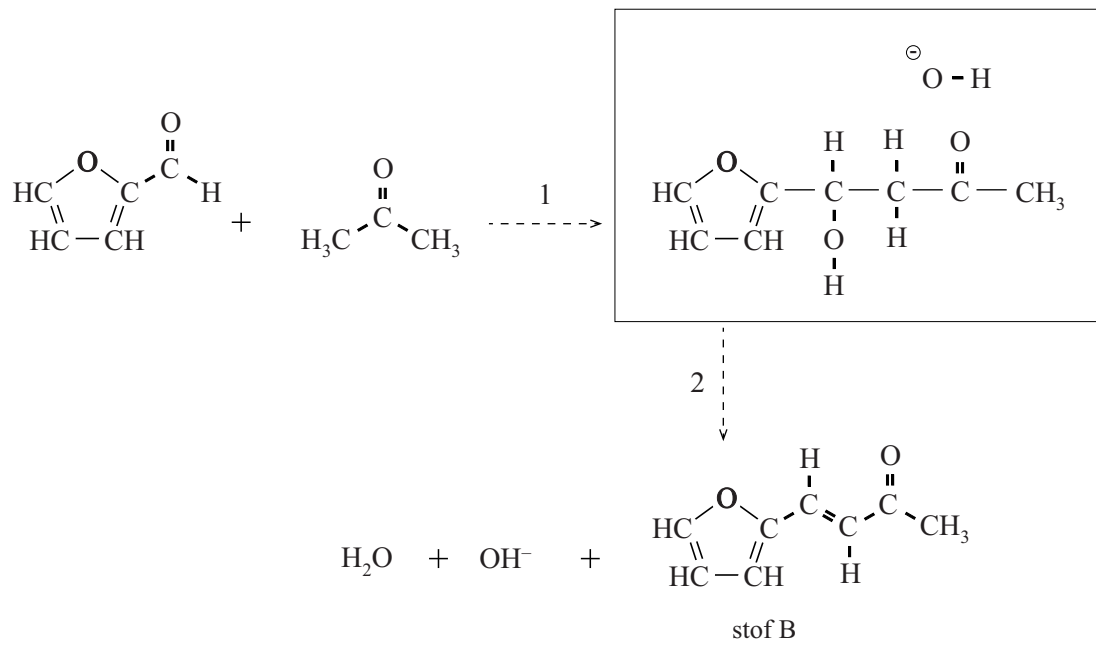

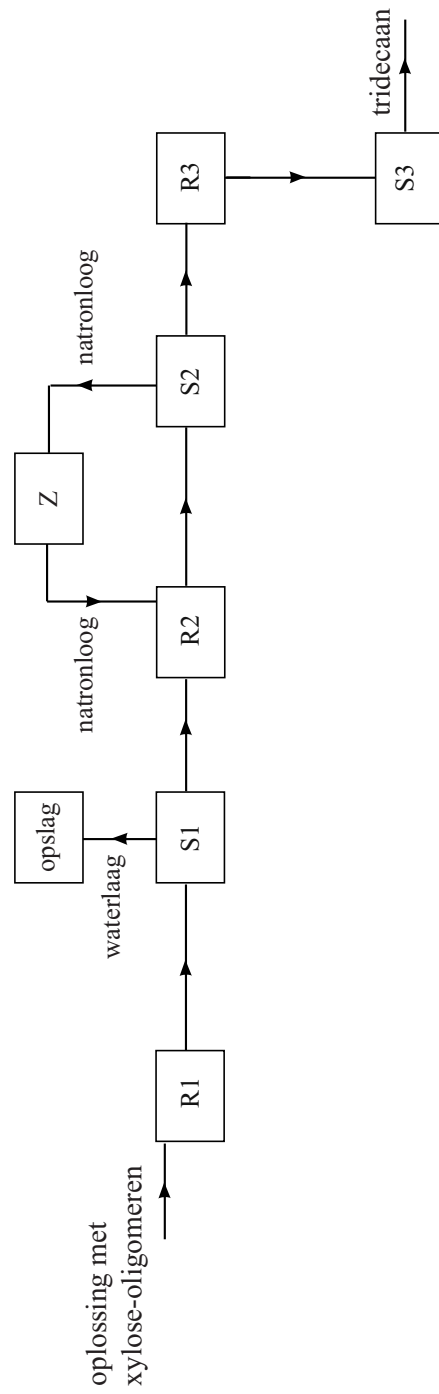

VERGEET NIET DEZE UITWERKBIJLAGE IN TE LEVEREN