

uitwerkbijlage

Naam kandidaat \_\_\_\_\_ Kandidaatnummer \_\_\_\_\_

3

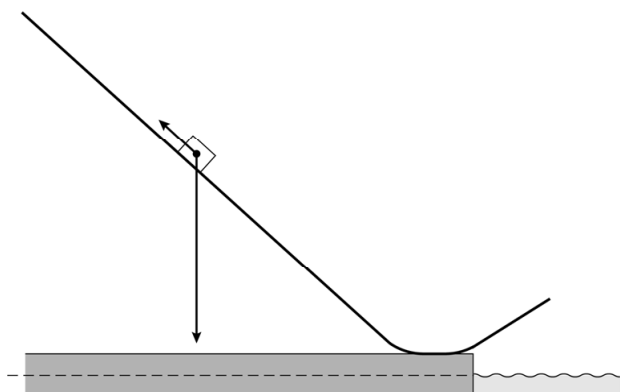

8

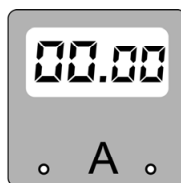

**VERGEET NIET DEZE UITWERKBIJLAGE IN TE LEVEREN**